



Perfis para Decoração

2025



PM-4217
0,344 Kg/m

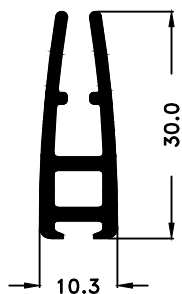

PM-5618
0,312 Kg/m

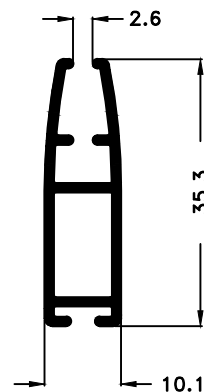

PM-0220
0,326 Kg/m

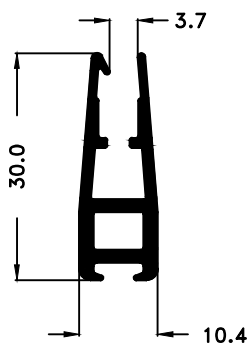

PM-6067
0,243 Kg/m

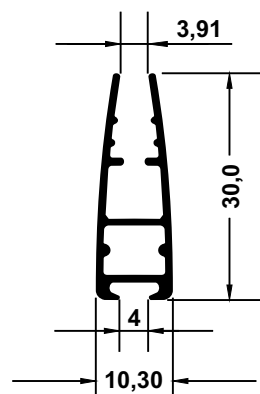

PM-5987
0,252 Kg/m

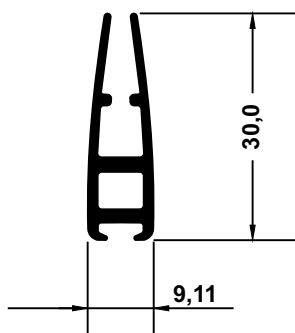

PM-3961
0,274 Kg/m

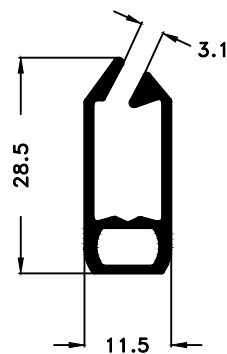



PM-1305
0,403 Kg/m

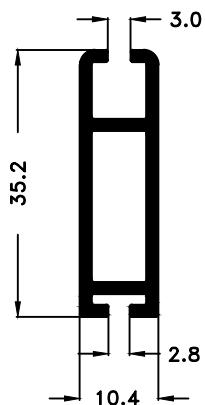

PM-4622
0,448 Kg/m

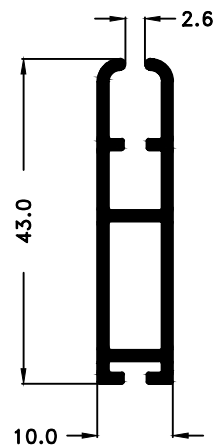

PM-2303
0,183 Kg/m

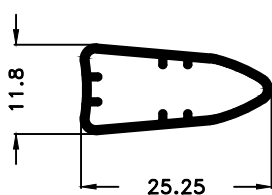

PM-2304
0,200 Kg/m

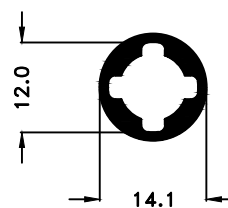

PM-1327
0,218 Kg/m

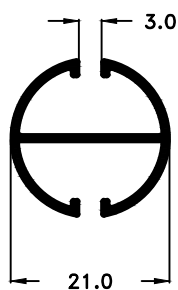

PM-5763
0,233 Kg/m

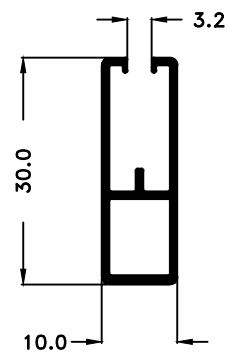



PM-5439
0,297 Kg/m

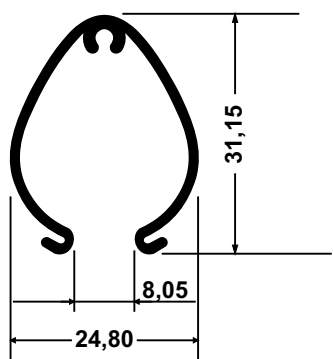

PM-5437
0,265 Kg/m

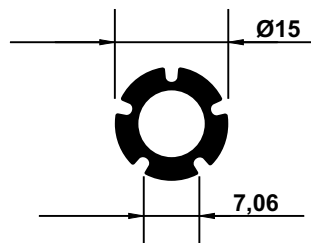

PM-0448
0,337 Kg/m

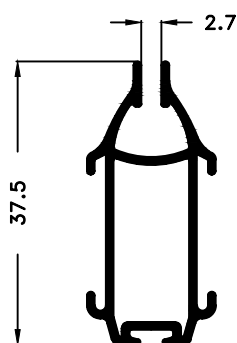

PM-5051
0,342 Kg/m

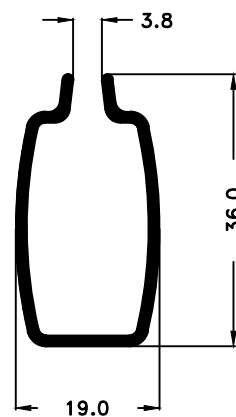

PM-2575
0,265 Kg/m

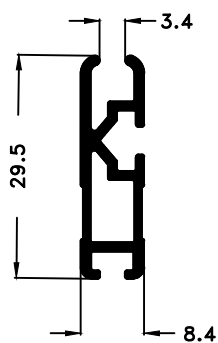



PM-5757
0,312 Kg/m

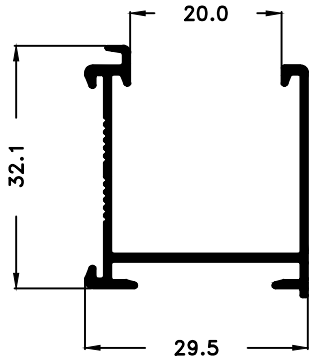

PM-4216
0,483 Kg/m

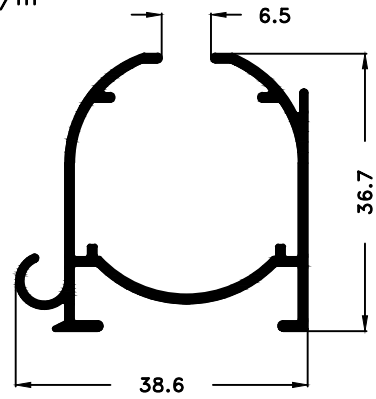

PM-5762
0,489 Kg/m

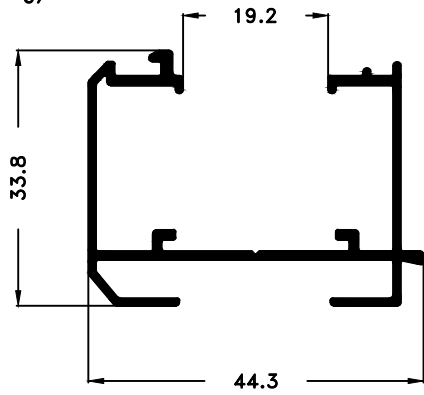

PM-3167
0,318 Kg/m

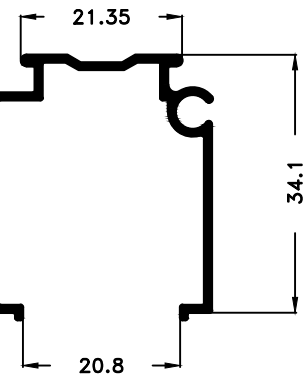

PM-1654
0,492 Kg/m

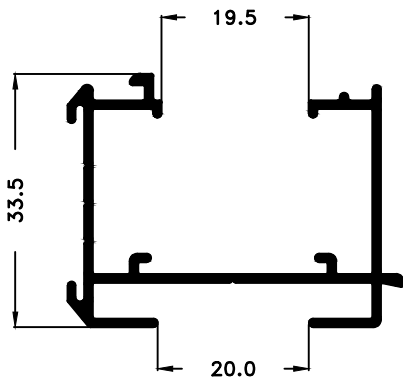

PM - 4510
0,446 Kg/m

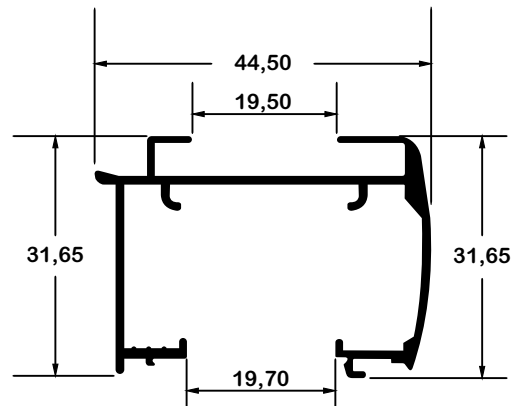



PM - 4550
0,480 Kg/m

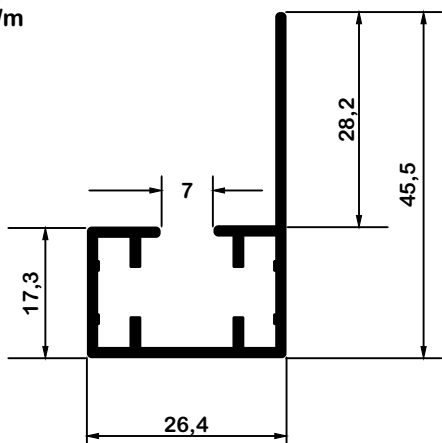



PM-1006
0,060 Kg/m

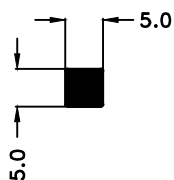

PM-0654
0,090 Kg/m

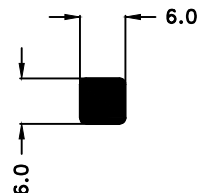

PM-0359
0,040 Kg/m

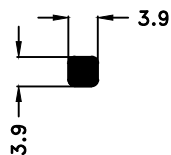

PM-1487
0,121 Kg/m

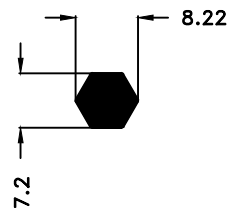

PM-1587
0,046 Kg/m

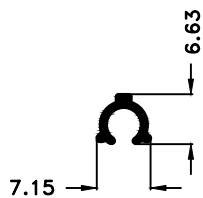

PM-3476
0,043 Kg/m

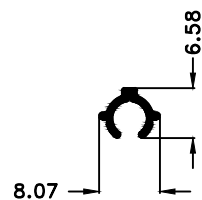



PM-1304
0,642 Kg/m

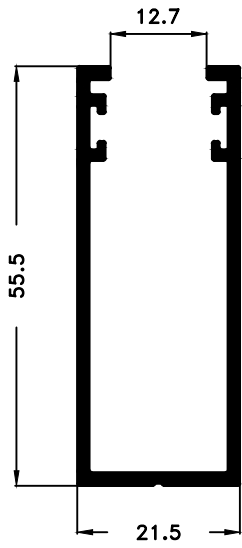

PM-5298
0,688 Kg/m

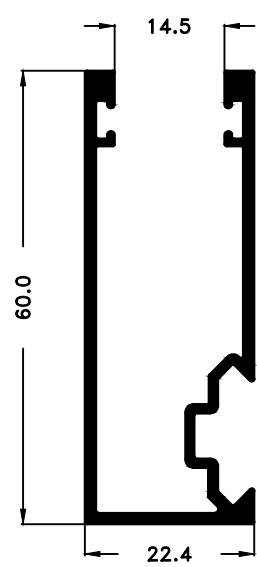

PM-1590
0,314 Kg/m

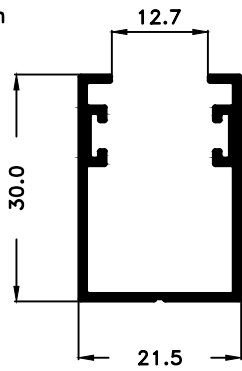

PM-5297
0,846 Kg/m

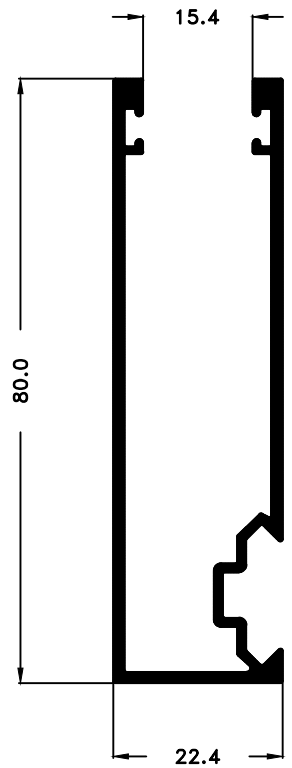



PM-2934
0,141 Kg/m

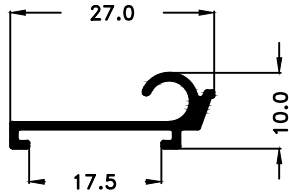

PM-1415
0,320 Kg/m

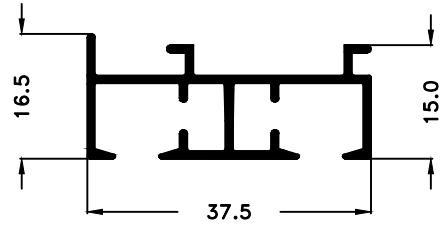

PM-1416
0,395 Kg/m

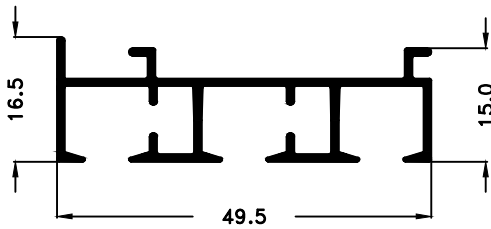

PM-3632
0,646 Kg/m

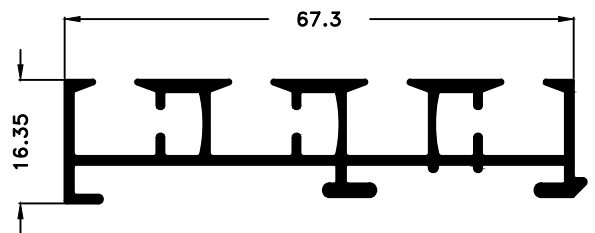

PM-0871
0,783 Kg/m

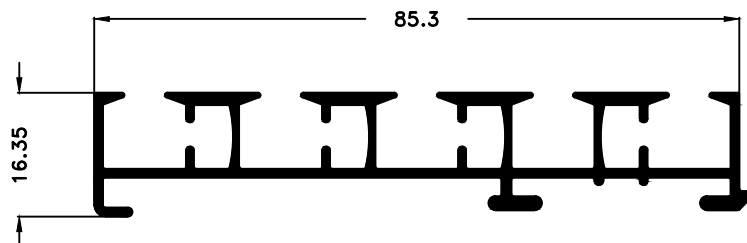



PM-0777
0,131 Kg/m

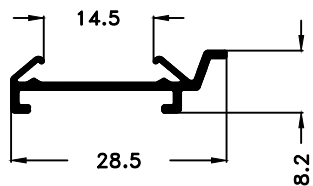



PM-1537
0,306 Kg/m

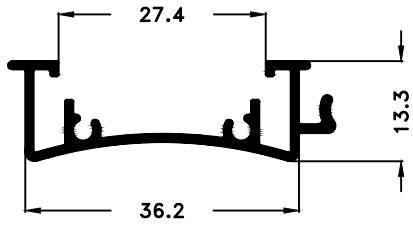

PM-4705
0,399 Kg/m

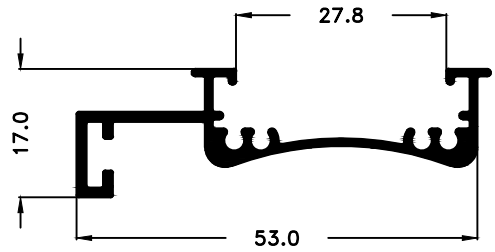

PM-1524
0,314 Kg/m

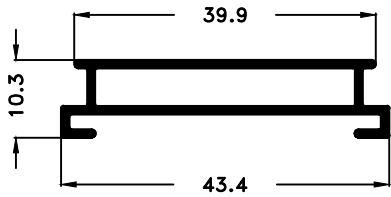

PM-4587
0,342 Kg/m

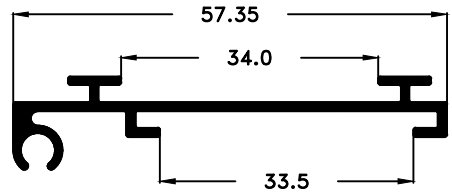

PM - 0293
0,230 Kg/m

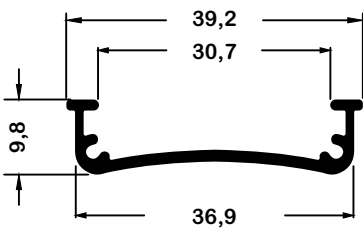

PM - 1953
0,316 Kg/m

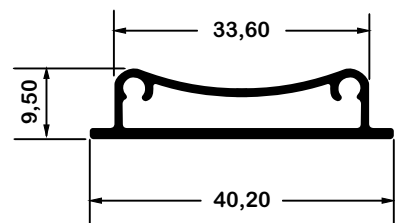



PM - 5257
0,383 Kg/m

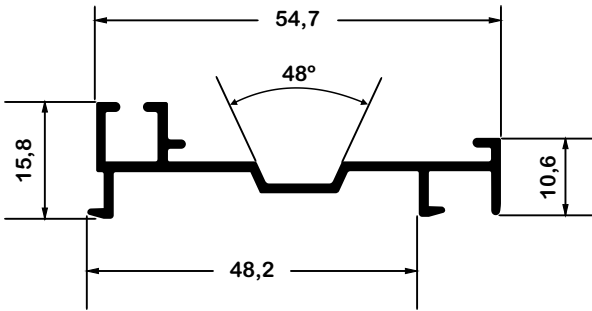



PM-5498
0,676 Kg/m

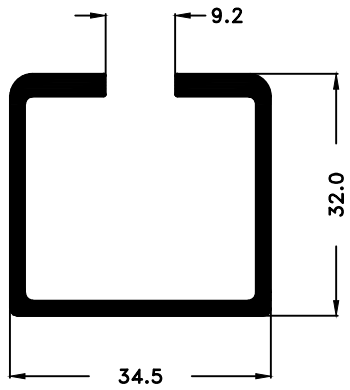

PM-5499
0,503 Kg/m

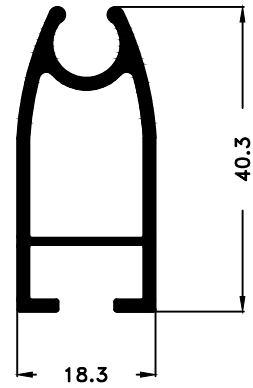

PM-3454
0,792 Kg/m

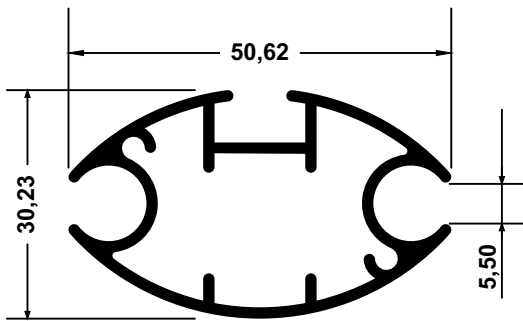

PM-3782
0,792 Kg/m

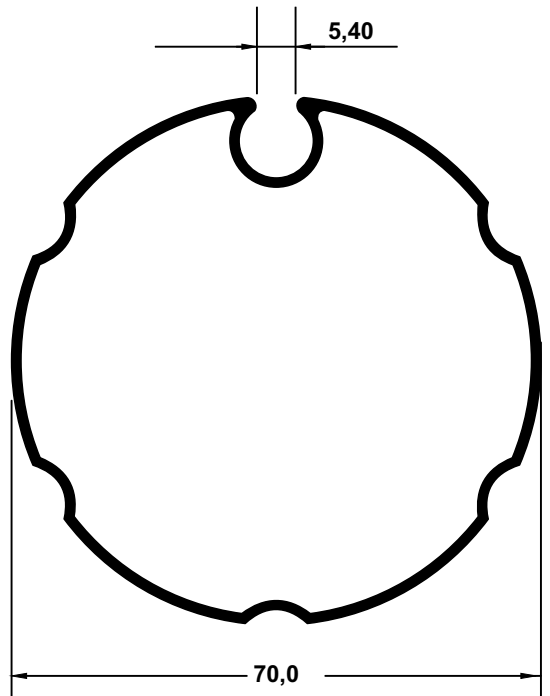



PM-3810
1,371 Kg/m

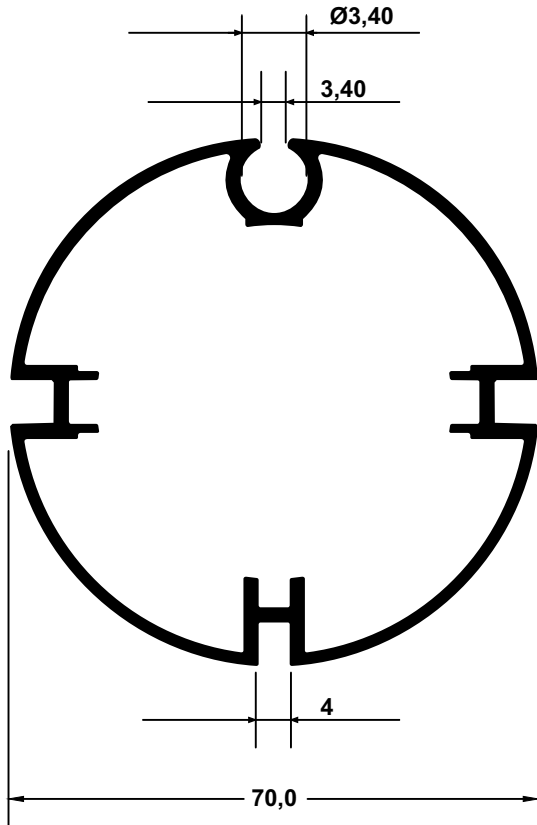



PM-3965
0,102 Kg/m

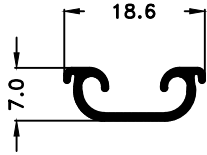

PM-5315
0,282 Kg/m

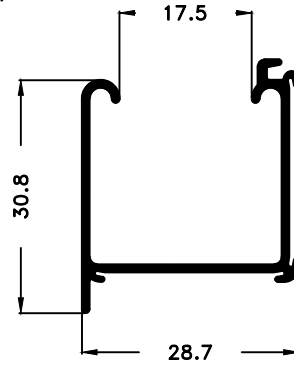

PM-3057
0,740 Kg/m

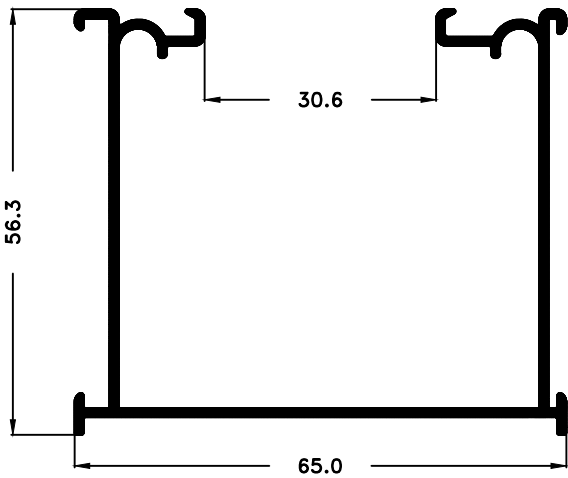



PM-2167
0,282 Kg/m

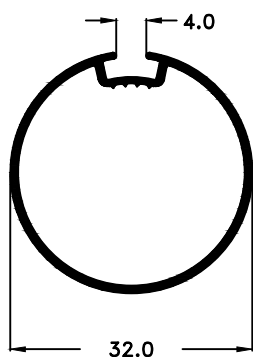

PM-5229
0,306 Kg/m

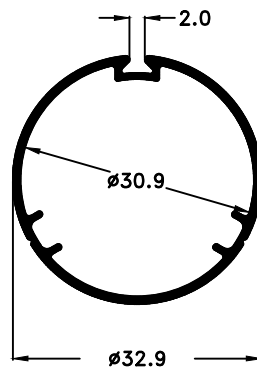

PM-2245
0,392 Kg/m

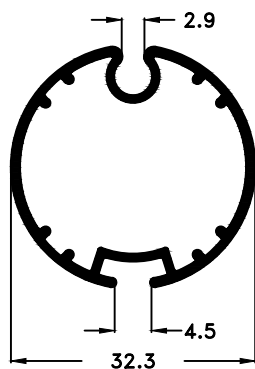

PM-4391
0,285 Kg/m

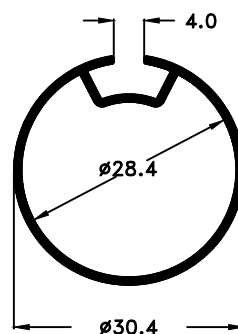

PM-1221
0,425 Kg/m

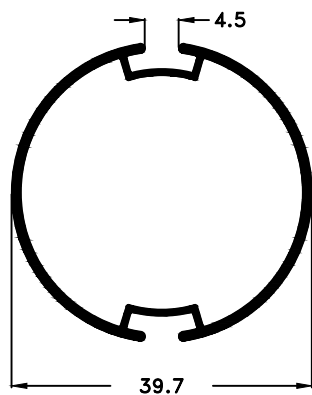

PM-2015
0,439 Kg/m

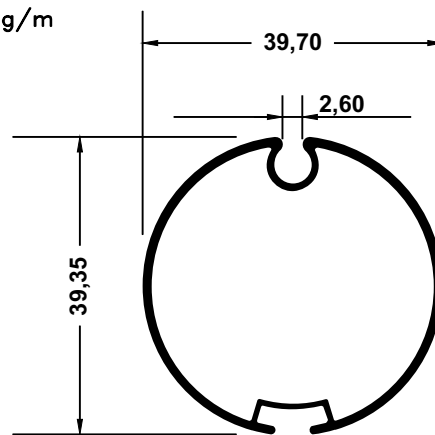



PM-6072
0,361 Kg/m

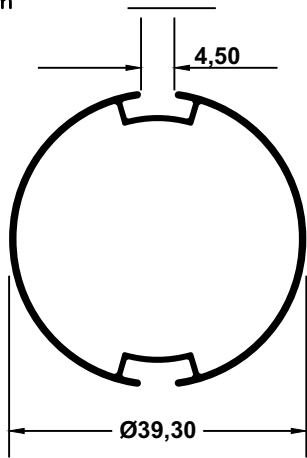

PM-3174
0,424 Kg/m

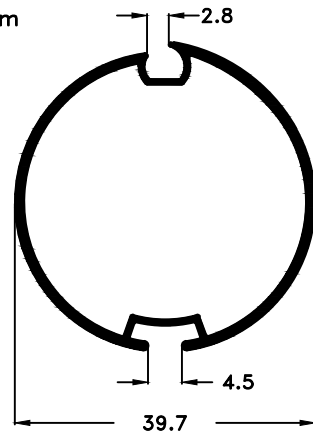

PM-3440
0,467 Kg/m

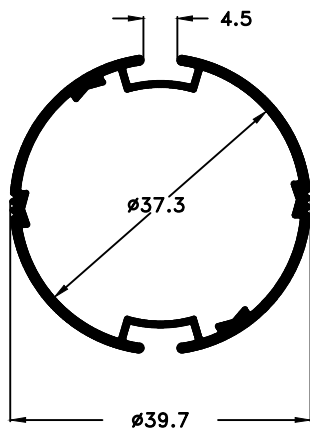

PM-1784
0,517 Kg/m

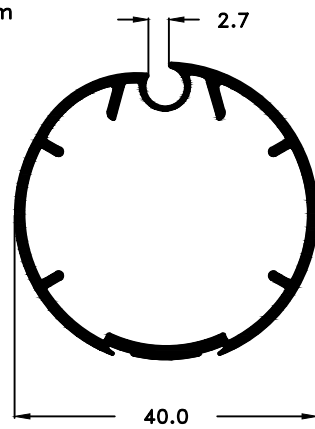

PM-0163
0,534 Kg/m

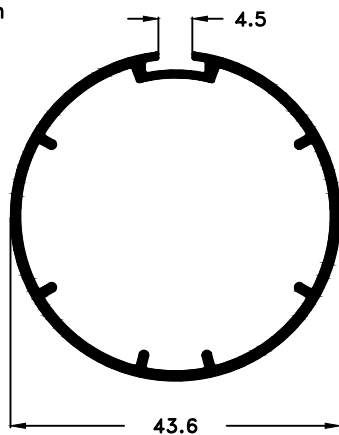

PM-0219
0,528 Kg/m

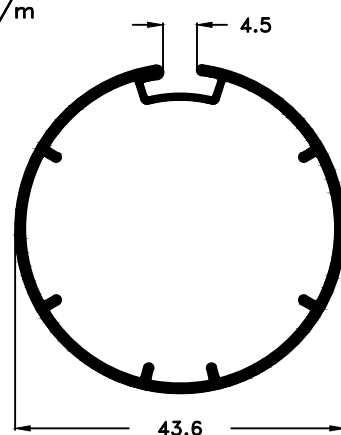



PM-1740
0,531 Kg/m

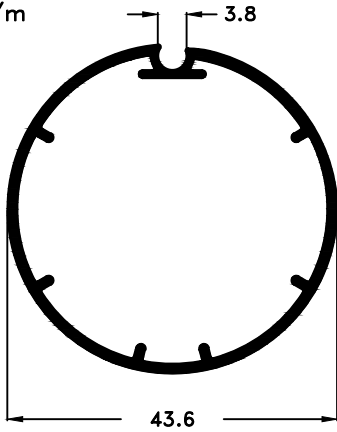

PM-5231
0,413 Kg/m

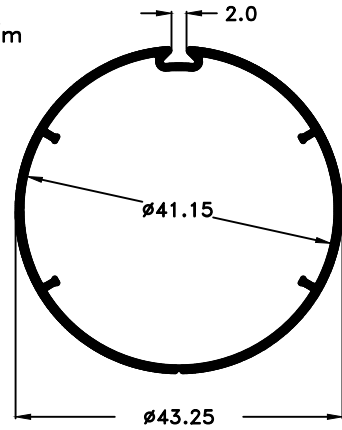

PM - 1952
0,585 Kg/m

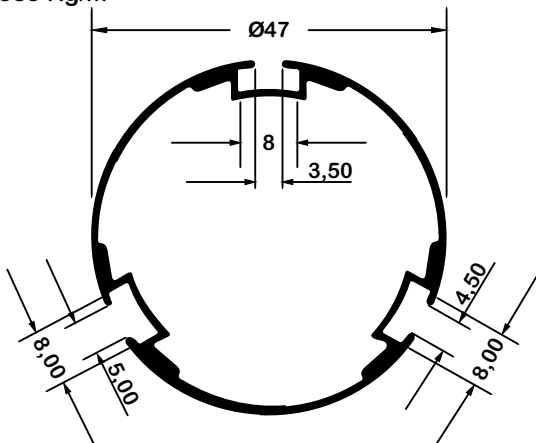

PM-2312
0,869 Kg/m

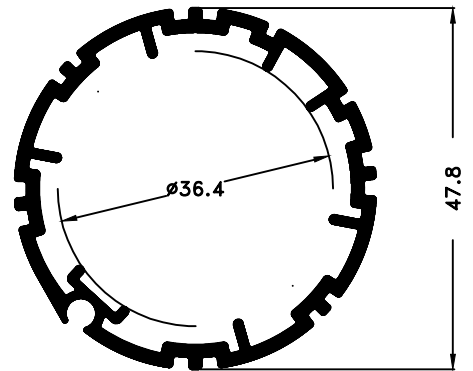

PM-2088
0,764 Kg/m

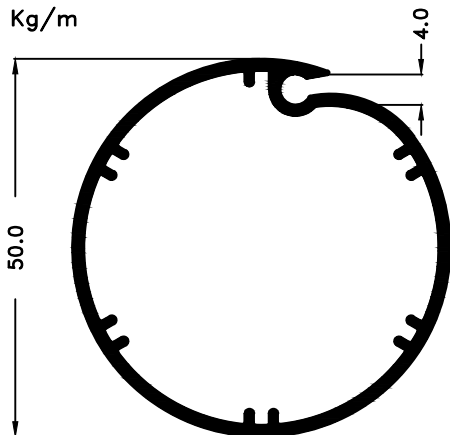

PM-3268
0,734 Kg/m

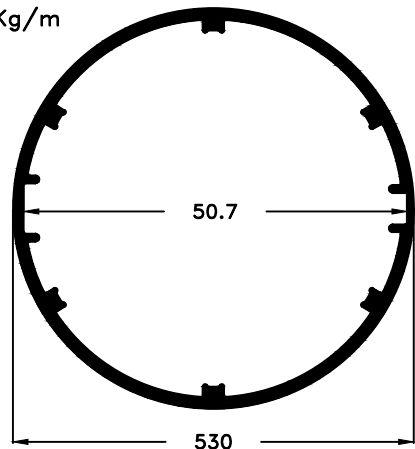



PM-5562
1,219 Kg/m

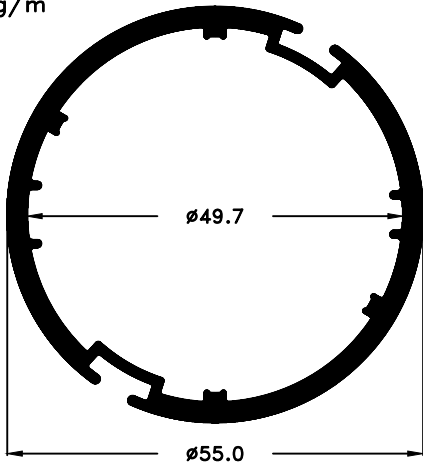

PM-4269
0,890 Kg/m

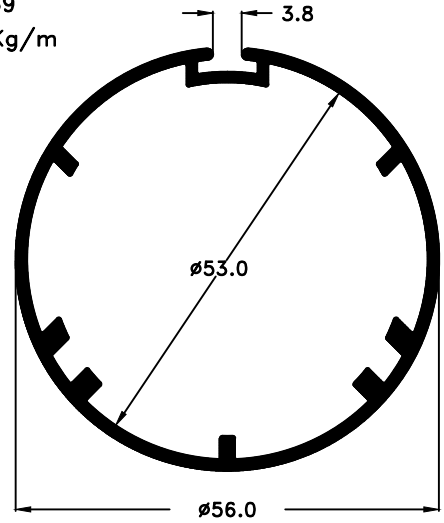

PM-4861
1,164 Kg/m

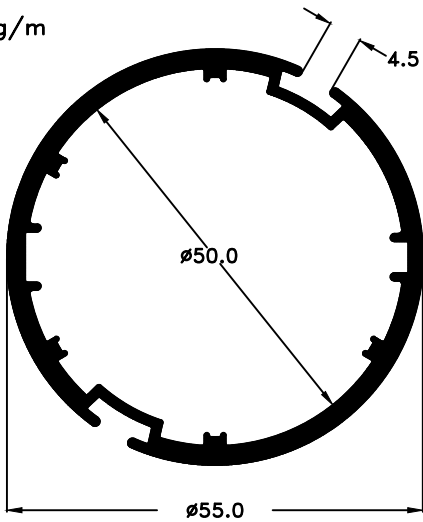

PM-2008
1,000 Kg/m

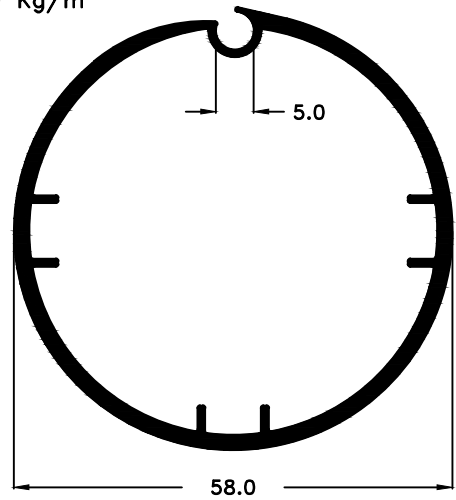



PM-1669
0,260 Kg/m

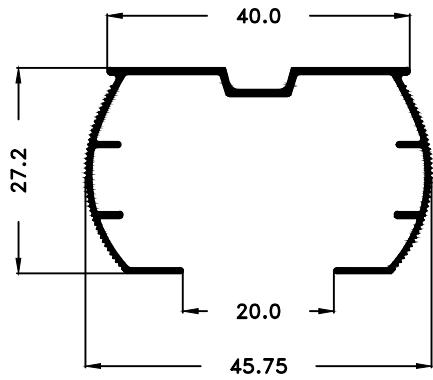

PM-1229
0,263 Kg/m

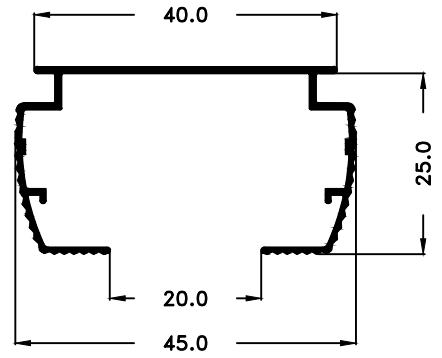

PM-0190
0,290 Kg/m

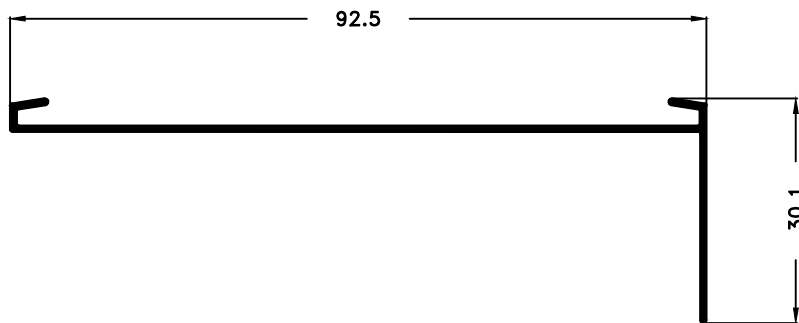

PM-0313
0,052 Kg/m

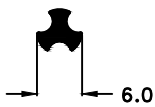

PM-0374
0,046 Kg/m

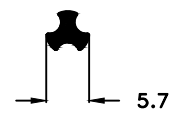



PM-0765
0,279 Kg/m

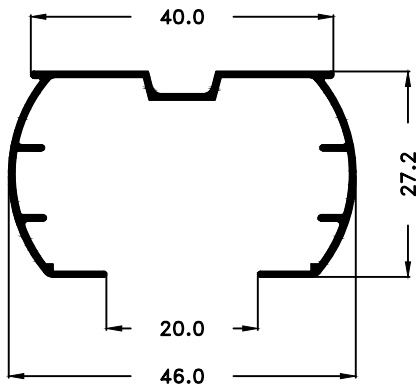

PM-0836
0,272 Kg/m

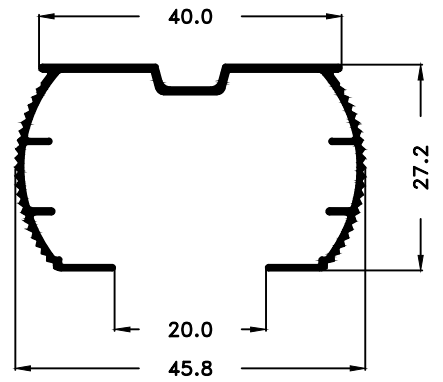

PM-0191
0,300 Kg/m

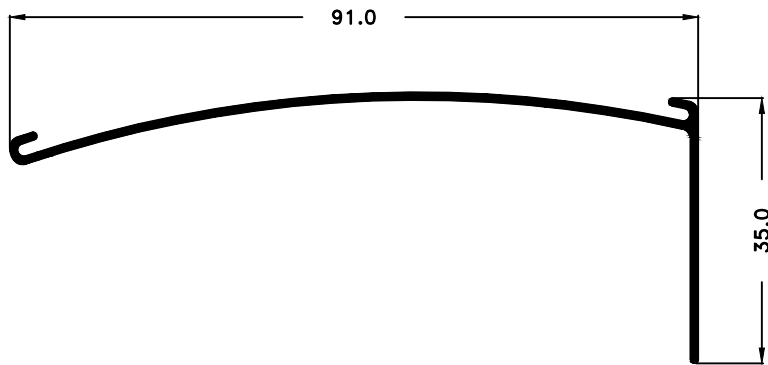

PM-5239
0,236 Kg/m

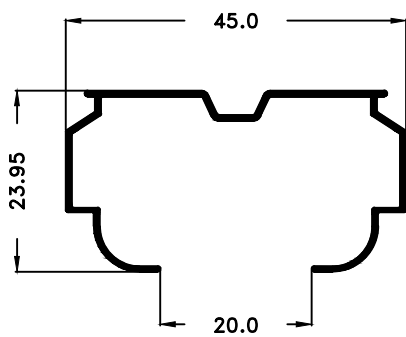

PM-2730
0,528 Kg/m

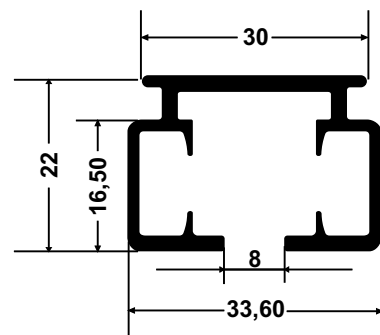



PM-6198
0,535 Kg/m

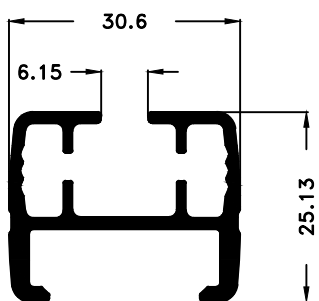

PM - 0399
0,826 Kg/m

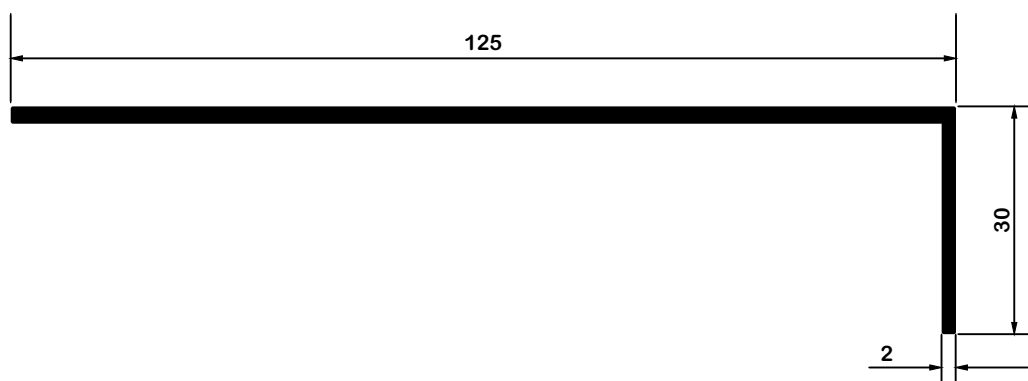



PM-2306
1,121 Kg/m

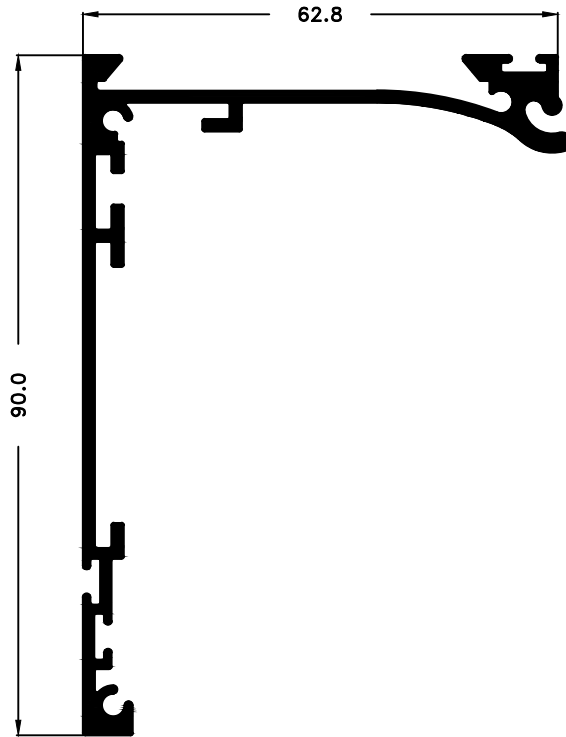

PM-2307
0,605 Kg/m

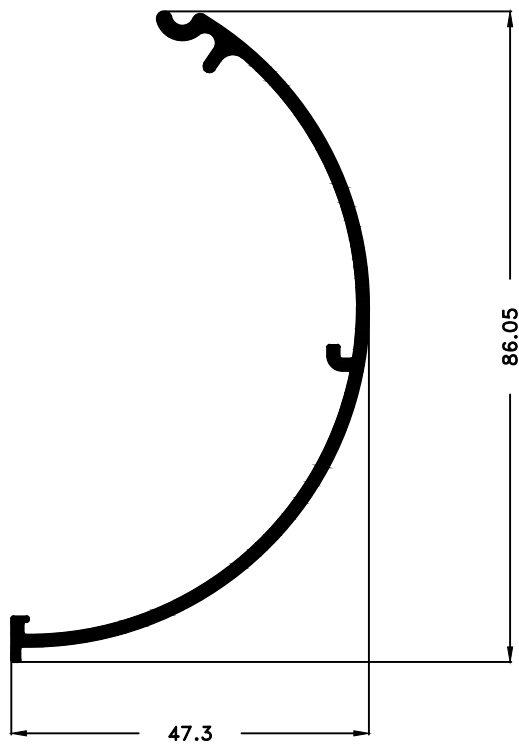

PM-2308
0,820 Kg/m

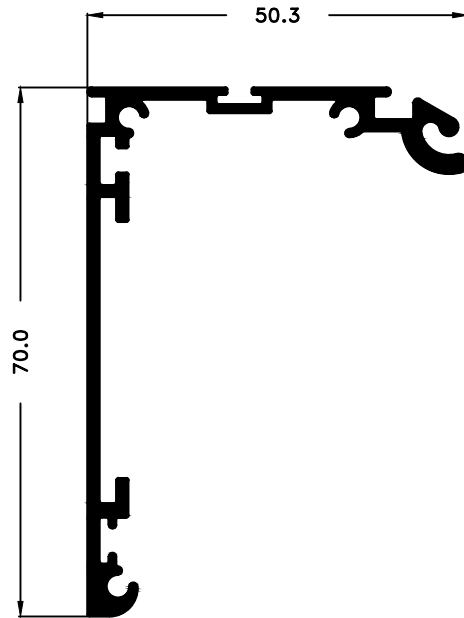

PM-2309
0,505 Kg/m

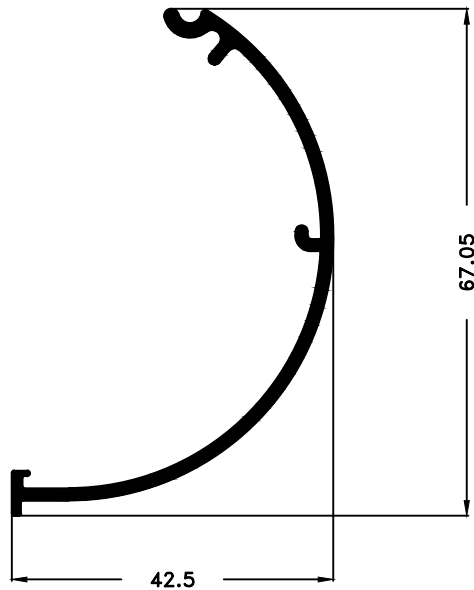

PM-4534
0,806 Kg/m

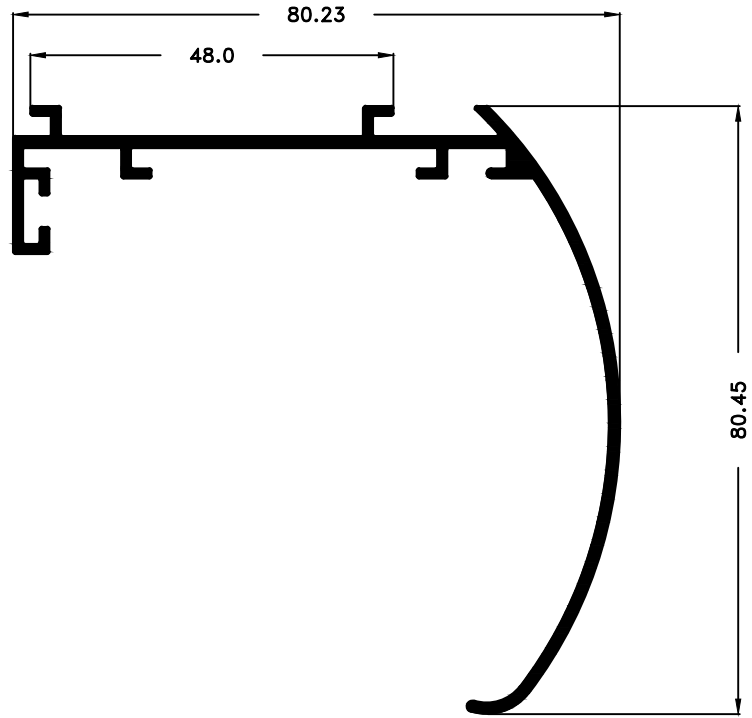

PM-5873
0,853 Kg/m

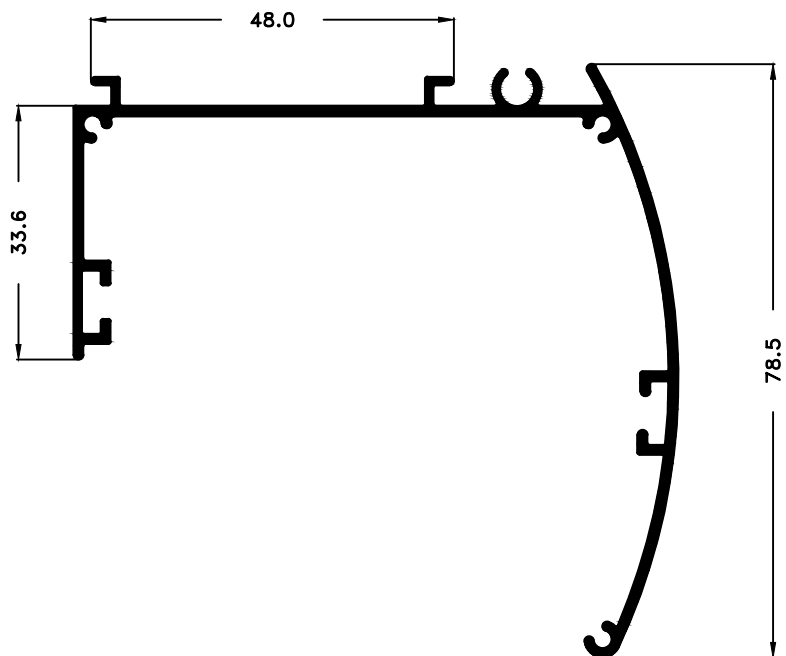

PM-4586
0,769 Kg/m

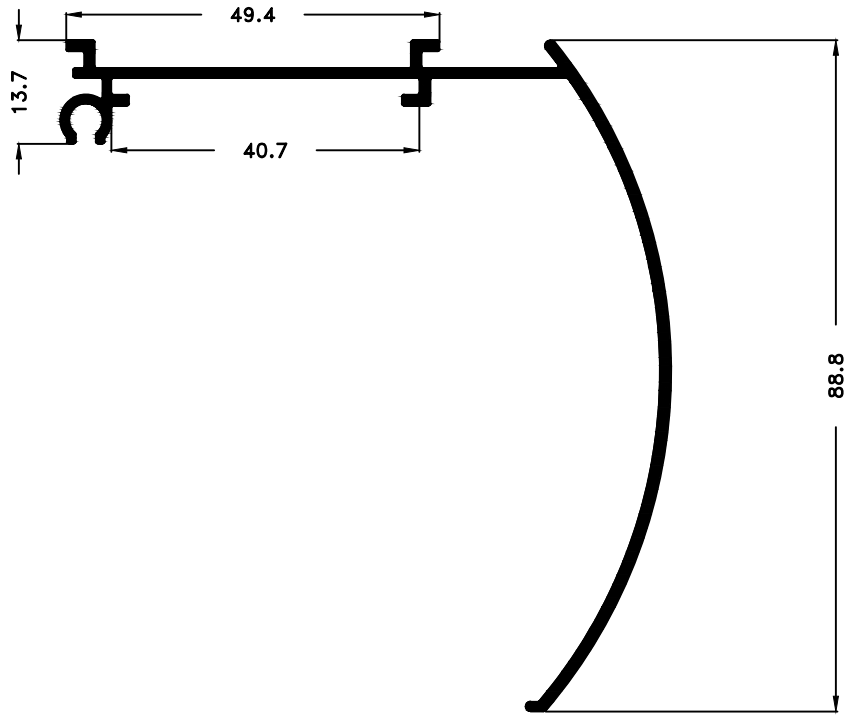

PM-1720
0,728 Kg/m

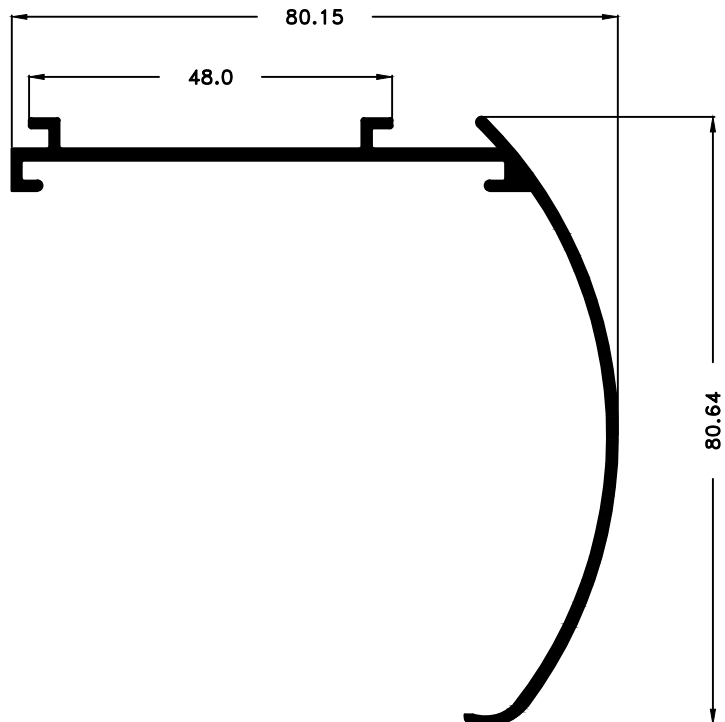

PM-4155
0,637 Kg/m

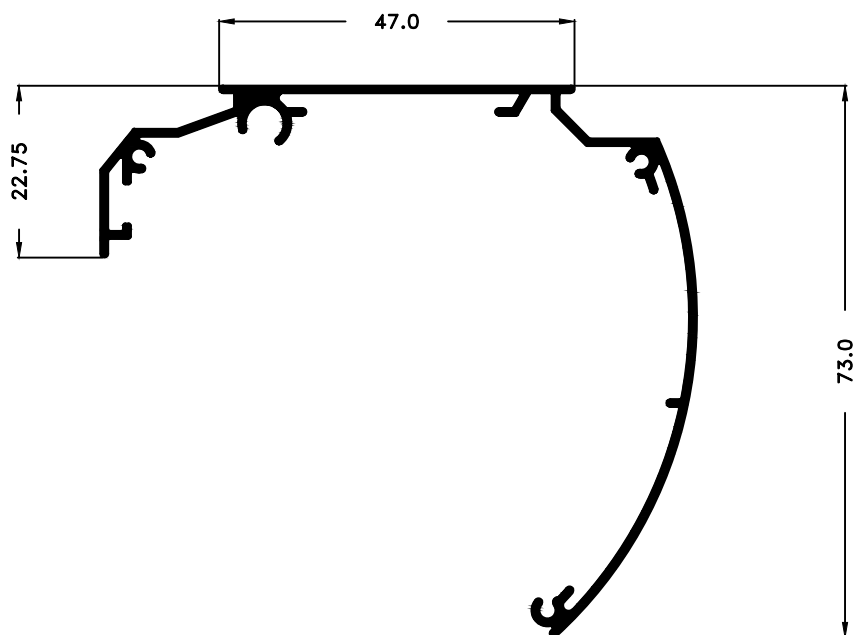

PM-4297
0,807 Kg/m

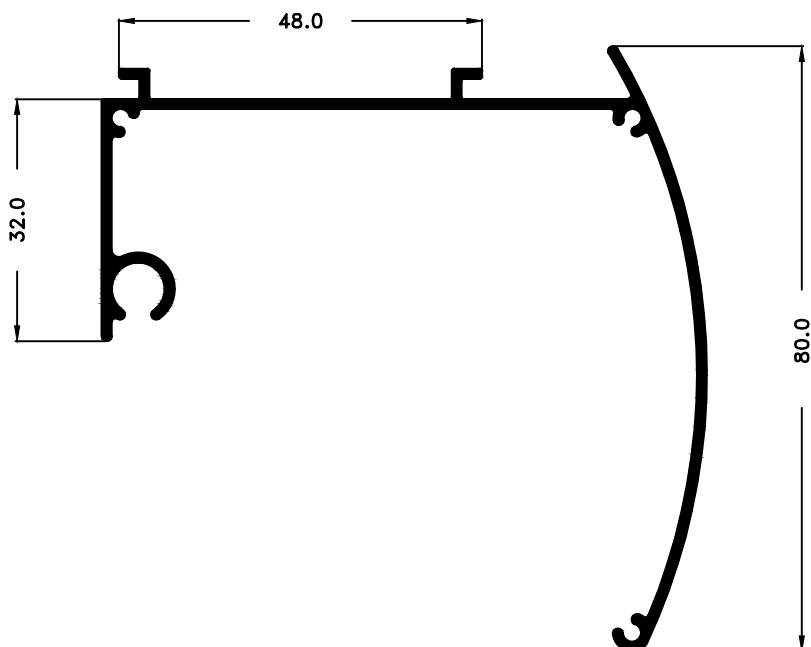



PM-5863
0,615 Kg/m

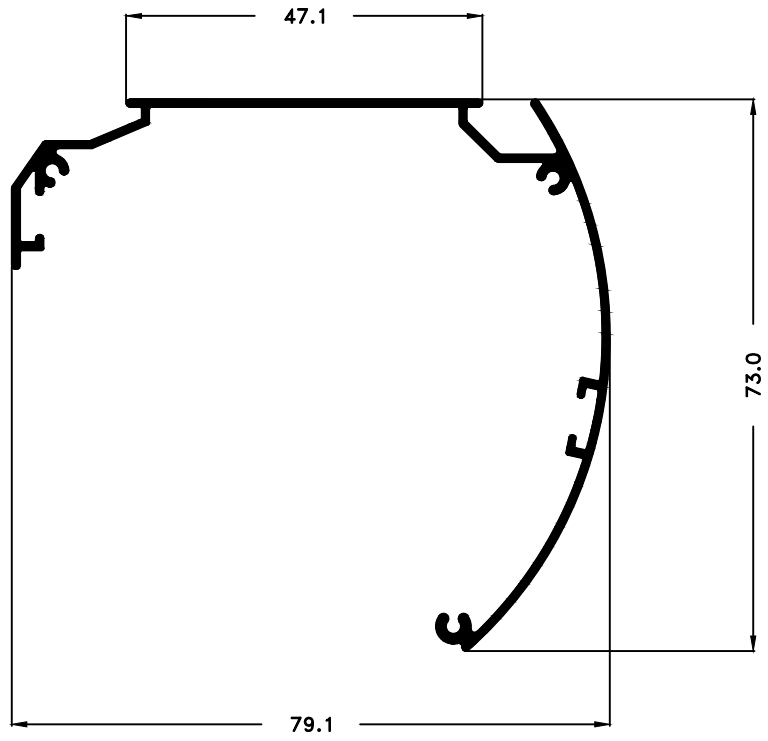

PM-3262
0,135 Kg/m

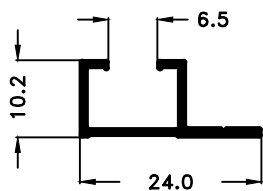

PM-3283
0,155 Kg/m

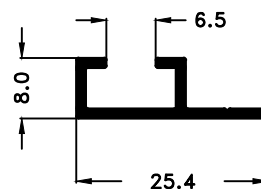

PM-3282
0,310 Kg/m

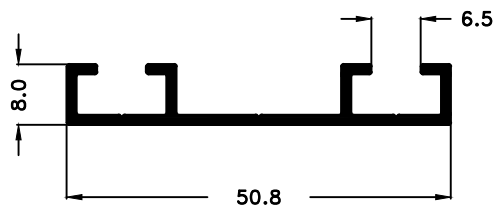

PM-5049
0,296 Kg/m

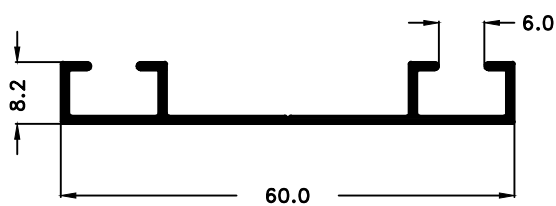

PM-5050
0,429 Kg/m

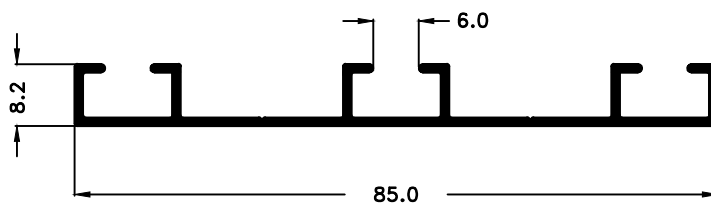



PM - 1914
0,121 Kg/m

